

Frontfarben Front colours

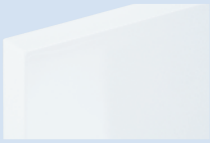

SMG_
MDF-foliert weiß Glanz
MDF-coated gloss white



SMF_
MDF-foliert anthrazit Glanz
MDF-coated gloss anthracite



SMO_
umlaufende Kunststoffkante Eiche Dekor braun
all-round plastic edge brown oak finish

Korpusfarben Basic shell colours

PG1



O/SM10
Eiche Dekor braun
brown oak finish

PG2

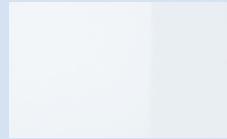

G/SM50
weiß Glanz
gloss white



F/SM30
anthrazit Glanz
gloss anthracite

i Spiegelschrank ISS80/100/120 nur mit Korpus »silber Glanz (SM99)« lieferbar!
Mirror cabinet ISS80/100/120 only available in basic shell colour »gloss silver (SM99)«!

Griffleiste Handlebar



Griffe Handles

⊕—⊕ = Bohrabstand/hole spacing

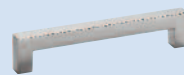

188
chrom Glanz
gloss chrome
⊕—⊕ 160 mm



126
chrom Glanz
gloss chrome
⊕—⊕ 450 mm



171
chrom Glanz
gloss chrome
⊕—⊕ 320 mm



170
chrom Glanz
gloss chrome
⊕—⊕ 588 mm

i Nicht alle Beistellschränke sind mit Griffleiste lieferbar.
Not all extra cabinets are available with handlebar.

Farb-Varianten/colour options »SMART«

Mineralmarmor Glanz Waschtische *Marble minerals gloss washbasins*

»Smart« (MWSE)

inkl. Clou-Überlaufsystem/*incl. clou overflow system*



MWSE101CS

Mineralmarmor Glanz/*marble minerals*

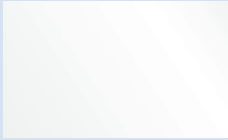







SM69
weiß Glanz
gloss white

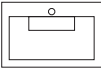
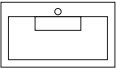
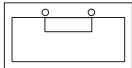
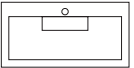
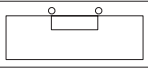



Smart Einzelartikel

Smart individuals

Circa-Maßangaben: Breite x Höhe x Tiefe (B x H x T cm)/Dimensions: width x height x depth (W x H x D cm)

| Waschtische/washbasins | | | | | | | | | |
|--|--|---|--|---|------|---------------------------|------|---------------------------|------|
| Mineralmarmor/marble minerals »Smart« | | | | | | | | | |
|  |  |  |  |  | | | | | |
| Waschtisch 1 Armaturloch inkl. Clou-Überlaufsystem <i>washbasin</i> 1 tap hole incl. Clou overflow system | Waschtisch 1 Armaturloch inkl. Clou-Überlaufsystem <i>washbasin</i> 1 tap hole incl. Clou overflow system | Waschtisch 2 Armaturlöcher inkl. Clou-Überlaufsystem <i>washbasin</i> 2 tap holes incl. Clou overflow system | Waschtisch 1 Armaturloch inkl. Clou-Überlaufsystem <i>washbasin</i> 1 tap hole incl. Clou overflow system | Waschtisch 2 Armaturlöcher inkl. Clou-Überlaufsystem <i>washbasin</i> 2 tap holes incl. Clou overflow system | | | | | |
| MIT Hahnloch/WITH tap hole | | | | | | | | | |
| 80,5 x 1,6 x 48,5 | | 100,5 x 1,6 x 48,5 | | 100,5 x 1,6 x 48,5 | | 120,5 x 1,6 x 48,5 | | 120,5 x 1,6 x 48,5 | |
| MWSE81CS | | MWSE101CS | | MWSE102CS | | MWSE121CS | | MWSE122CS | |
| weiß Glanz gloss white | 1470 | weiß Glanz gloss white | 1588 | weiß Glanz gloss white | 1588 | weiß Glanz gloss white | 1735 | weiß Glanz gloss white | 1735 |
| OHNE Hahnloch/WITHOUT tap hole | | | | | | | | | |
| 80,5 x 1,6 x 48,5 | | 100,5 x 1,6 x 48,5 | | | | 120,5 x 1,6 x 48,5 | | | |
| MWSE80CS | | MWSE100CS | | | | MWSE120CS | | | |
| weiß Glanz gloss white | 1470 | weiß Glanz gloss white | 1588 | | | weiß Glanz gloss white | 1735 | | |



| Waschtischunterschranke/washbasin base cabinets | | | | | | | | | | | |
|--|--|--|--|--|--|----------------|------|-----------------|------|-----------------|------|
| Mit Vollauszug/with full extension | | | | | | | | | | | |
|  |  |  |  |  |  | | | | | | |
| Waschtischunterschrank 2 Auszüge <i>washbasin base cabinet</i> 2 extensions | Waschtischunterschrank 2 Auszüge <i>washbasin base cabinet</i> 2 extensions | Waschtischunterschrank 2 Auszüge <i>washbasin base cabinet</i> 2 extensions | Waschtischunterschrank 2 Auszüge <i>washbasin base cabinet</i> 2 extensions | Waschtischunterschrank 2 Auszüge <i>washbasin base cabinet</i> 2 extensions | Waschtischunterschrank 2 Auszüge <i>washbasin base cabinet</i> 2 extensions | | | | | | |
| 80 x 47,8 x 48 | | 100 x 47,8 x 48 | | 120 x 47,8 x 48 | | 80 x 47,8 x 48 | | 100 x 47,8 x 48 | | 120 x 47,8 x 48 | |
| MWU82D | | MWU102D | | MWU122D | | IWU82D | | IWU102D | | IWU122D | |
| PG1 | 1235 | PG1 | 1352 | PG1 | 1705 | PG1 | 1676 | PG1 | 1882 | PG1 | 2087 |
| PG2 | 1529 | PG2 | 1646 | PG2 | 1999 | PG2 | 1970 | PG2 | 2176 | PG2 | 2381 |

| Zubehör/accessoirres | | | |
|---|---|---|---|
| SMX3 | | | |
|  |  |  |  |
| Inneneinteilung für 80 cm Auszug <i>internal subdivision</i> for 80 cm extension | Inneneinteilung für 100 cm Auszug <i>internal subdivision</i> for 100 cm extension | Inneneinteilung für 120 cm Auszug <i>internal subdivision</i> for 120 cm extension | Handtuchhalter verchromt (Befestigung am Schrank) <i>chromed towel rail</i> (fastening on the cabinet) |
| IE80D | IE100D | IE120D | MHH |
| 74 | 74 | 74 | 235 |



Smart Einzelartikel



Smart individuals

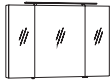

Circa-Maßangaben: Beite x Höhe x Tiefe (B x H x T cm) / Dimensions: width x height x depth (W x H x D cm)

| Schiebetüren-Spiegelschränke/mirror cabinets with sliding doors | | |
|---|---|---|
| SM99 | | |
|  |  |  |
| mit Beleuchtung (4x 3,5W PowerLED) inkl. Schalter/Steckdose 2 Glaseinlegeböden | mit Beleuchtung (4x 3,5W PowerLED) inkl. Schalter/Steckdose 2 Glaseinlegeböden | mit Beleuchtung (4x 3,5W PowerLED) inkl. Schalter/Steckdose 2 Glaseinlegeböden |
| <i>with lighting (4x 3,5W PowerLED) incl. switch/socket 2 glass shelves</i> | <i>with lighting (4x 3,5W PowerLED) incl. switch/socket 2 glass shelves</i> | <i>with lighting (4x 3,5W PowerLED) incl. switch/socket 2 glass shelves</i> |
| 80 x 68,2 x 17 | 100 x 68,2 x 17 | 120 x 68,2 x 17 |
| ISS80 | ISS100 | ISS120 |
| 2934 | 3228 | 3522 |

| Zubehör/accessories | |
|--|--|
| SMX30 | |
|  |  |
| Spiegelschrank- Unterbaubeleuchtung 70 cm (3W LED, für Spiegelschrank 80/100 cm) | Spiegelschrank- Unterbaubeleuchtung 110 cm (4,3W LED, für Spiegelschrank 120 cm) |
| <i>base lighting for mirror cabinet 70 cm (3W LED, for mirror cabinet 80/100 cm)</i> | <i>base lighting for mirror cabinet 110 cm (4,3W LED, for mirror cabinet 120 cm)</i> |
| WTB70 | WTB110 |
| 265 | 382 |

| Spiegelschränke/mirror cabinets | | |
|---|---|---|
| mit Dämpfung/with damping | | |
|  |  |  |
| mit Beleuchtung (3x 3,5W PowerLED) und Glasschirm inkl. Schalter/Steckdose 2 Glaseinlegeböden | mit Beleuchtung (3x 3,5W PowerLED) und Glasschirm inkl. Schalter/Steckdose 4 Glaseinlegeböden | mit Beleuchtung (3x 3,5W PowerLED) und Glasschirm inkl. Schalter/Steckdose 4 Glaseinlegeböden |
| <i>with lighting (3x 3,5W PowerLED) and glass shade incl. switch/socket 2 glass shelves</i> | <i>with lighting (3x 3,5W PowerLED) and glass shade incl. switch/socket 4 glass shelves</i> | <i>with lighting (3x 3,5W PowerLED) and glass shade incl. switch/socket 4 glass shelves</i> |
| 80 x 68,2 x 13,6 | 100 x 68,2 x 13,6 | 120 x 68,2 x 13,6 |
| SPSGL80D | SPSGL100D | SPSGL120D |
| 2205 | 2346 | 2793 |







| Spiegelpaneele/mirror panels | | |
|--|---|---|
| SMX3 | | |
|  |  |  |
| mit Beleuchtung (3x 3,5W PowerLED) und Glasschirm | mit Beleuchtung (3x 3,5W PowerLED) und Glasschirm | mit Beleuchtung (3x 3,5W PowerLED) und Glasschirm |
| <i>with lighting (3x 3,5W PowerLED) and glass shade</i> | <i>with lighting (3x 3,5W PowerLED) and glass shade</i> | <i>with lighting (3x 3,5W PowerLED) and glass shade</i> |
| 80 x 68,2 x 2 | 100 x 68,2 x 2 | 120 x 68,2 x 2 |
| SPGL80 | SPGL100 | SPGL120 |
| 1411 | 1441 | 1705 |



| Steckböden/plug-in shelves | | |
|--|--|--|
|  |  |  |
| in Korpusfarbe (Unterseite weiß) inkl. 2 verchromten Wandhaltern | in Korpusfarbe (Unterseite weiß) inkl. 2 verchromten Wandhaltern | in Korpusfarbe (Unterseite weiß) inkl. 2 verchromten Wandhaltern |
| <i>in basic shell colour (white bottom) incl. 2 chromed wall attachments</i> | <i>in basic shell colour (white bottom) incl. 2 chromed wall attachments</i> | <i>in basic shell colour (white bottom) incl. 2 chromed wall attachments</i> |
| 80 x 1,6 x 12 | 100 x 1,6 x 12 | 120 x 1,6 x 12 |
| SB80 | SB100 | SB120 |
| 235 | 265 | 294 |





Smart Einzelartikel

Smart individuals

Circa-Maßangaben: Breite x Höhe x Tiefe (B x H x T cm)/Dimensions: width x height x depth (W x H x D cm)

| Schränke mit Griff/cabinets with handle | | | | | | | | | | | |
|--|-----|---|------|--|------|---|------|---|------|--|------|
| Highboards | | | | Mittelschränke/medium cabinets | | | | Hochschränke/tower cabinets | | | |
|  <p>1 Tür 2 Glaseinlegeböden 1 Abdeckplatte</p> <p>1 door 2 glass shelves 1 top</p> | |  <p>1 Tür/Wäschekippe 1 Abdeckplatte</p> <p>1 door/linen bin 1 top</p> | |  <p>1 Tür 2 Glaseinlegeböden 2 Schubkästen 1 Abdeckplatte</p> <p>1 door 2 glass shelves 2 drawers 1 top</p> | |  <p>2 Türen 2 Glaseinlegeböden 2 Schubkästen 1 Abdeckplatte</p> <p>2 doors 2 glass shelves 2 drawers 1 top</p> | |  <p>1 Tür 2 Glaseinlegeböden 3 Schubkästen</p> <p>1 door 2 glass shelves 3 drawers</p> | |  <p>2 Türen 4 Glaseinlegeböden</p> <p>2 doors 4 glass shelves</p> | |
| mit Vollauszug inkl. Dämpfung/with full extension incl. damping | | | | | | | | | | | |
| 40 x 91,9 x 34,8 | | 40 x 91,9 x 34,8 | | 40 x 149,5 x 34,8 | | 60 x 149,5 x 34,8 | | 40 x 178,7 x 34,8 | | 40 x 178,7 x 34,8 | |
| MHB400D_ L/R | | MHBW400D_ L/R | | MMI400D_ L/R | | MMI600D_ L/R | | MHA400D L/R | | MHT400D L/R | |
| PG1 | 676 | PG1 | 794 | PG1 | 1323 | PG1 | 1764 | PG1 | 1617 | PG1 | 1000 |
| PG2 | 970 | PG2 | 1088 | PG2 | 1793 | PG2 | 2234 | PG2 | 2087 | PG2 | 1470 |

| Schränke mit Griff/cabinets with handle | | | | | |
|--|------|---|------|---|------|
| Hochschränke/tower cabinets | | | | | |
|  <p>1 Tür 2 Glaseinlegeböden 1 Wäschekippe</p> <p>1 door 2 glass shelves 1 linen bin</p> | |  <p>2 Türen 1 Schubkasten</p> <p>2 doors 1 drawer</p> | |  <p>2 Türen 2 Glaseinlegeböden 3 Schubkästen</p> <p>2 doors 2 glass shelves 3 drawers</p> | |
| mit Vollauszug inkl. Dämpfung/with full extension incl. damping | | | | | |
| 40 x 178,7 x 34,8 | | 40 x 178,7 x 34,8 | | 60 x 178,7 x 34,8 | |
| MHW400D L/R | | MH407D L/R | | MHA600D L/R | |
| PG1 | 1117 | PG1 | 1294 | PG1 | 2176 |
| PG2 | 1588 | PG2 | 1764 | PG2 | 2646 |

| Schränke mit Griffleiste/cabinets with handlebar | | | | | | | | | |
|--|------|---|------|--|------|--|------|---|------|
| Highboards | | | | Mittelschrank/medium cab. | | Hochschränke/tower cabinets | | | |
|  <p>1 Tür 2 Glaseinlegeböden 1 Abdeckplatte</p> <p>1 door 2 glass shelves 1 top</p> | |  <p>1 Tür/Wäschekippe 1 Abdeckplatte</p> <p>1 door/linen bin 1 top</p> | |  <p>1 Tür 2 Glaseinlegeböden 2 Schubkästen 1 Abdeckplatte</p> <p>1 door 2 glass shelves 2 drawers 1 top</p> | |  <p>2 Türen 4 Glaseinlegeböden</p> <p>2 doors 4 glass shelves</p> | |  <p>1 Tür 2 Glaseinlegeböden 1 Wäschekippe</p> <p>1 door 2 glass shelves 1 linen bin</p> | |
| 40 x 91,9 x 34,8 | | 40 x 91,9 x 34,8 | | 40 x 149,5 x 34,8 | | 40 x 178,7 x 34,8 | | 40 x 178,7 x 34,8 | |
| IHB400D_ L/R | | IHBW400D_ L/R | | IMI400D_ L/R | | IHT400D_ L/R | | IHW400D_ L/R | |
| PG1 | 824 | PG1 | 941 | PG1 | 1588 | PG1 | 1294 | PG1 | 1412 |
| PG2 | 1118 | PG2 | 1235 | PG2 | 2058 | PG2 | 1764 | PG2 | 1882 |

Smart Vorschlagskombinationen

Smart suggested combinations

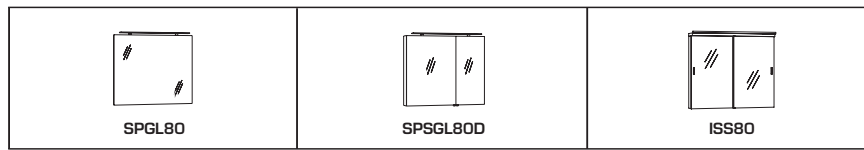

| | | PG1 | PG2 | PG1 | PG2 | PG1 | PG2 |
|--|--------|-----------------------|------|-----------------------|------|-----------------------|------|
| plus Waschtisch/plus washbasin »SMART 80« | | | | | | | |
| | | MWSE81CS MWSE80CS* | | MWSE81CS MWSE80CS* | | MWSE81CS MWSE80CS* | |
| plus Unterschrank/plus base cabinet | | | | | | | |
| | MWU82D | 4116 | 4410 | 4910 | 5204 | 5639 | 5933 |
| | IWU82D | 4557 | 4851 | 5351 | 5645 | 6080 | 6374 |

* ohne Hahnloch (preisgleich)/without tap hole (same price)

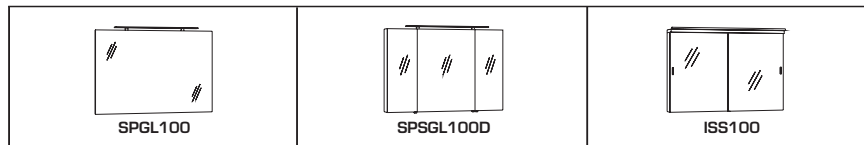

| | | PG1 | PG2 | PG1 | PG2 | PG1 | PG2 |
|---|---------|--|------|--|------|--|------|
| plus Waschtisch/plus washbasin »SMART 100« | | | | | | | |
| | | MWSE101CS MWSE100CS* MWSE102CS** | | MWSE101CS MWSE100CS* MWSE102CS** | | MWSE101CS MWSE100CS* MWSE102CS** | |
| plus Unterschrank/plus base cabinet | | | | | | | |
| | MWU102D | 4381 | 4675 | 5286 | 5580 | 6168 | 6462 |
| | IWU102D | 5116 | 5410 | 6021 | 6315 | 6903 | 7197 |

* ohne Hahnloch (preisgleich)/without tap hole (same price)

** zusätzliches Hahnloch (alle preisgleich/additional tap hole (same price))

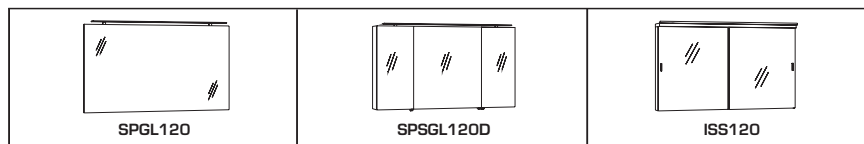

| | | PG1 | PG2 | PG1 | PG2 | PG1 | PG2 |
|---|---------|--|------|--|------|--|------|
| plus Waschtisch/plus washbasin »SMART 120« | | | | | | | |
| | | MWSE121CS MWSE120CS* MWSE122CS** | | MWSE121CS MWSE120CS* MWSE122CS** | | MWSE121CS MWSE120CS* MWSE122CS** | |
| plus Unterschrank/plus base cabinet | | | | | | | |
| | MWU120D | 5145 | 5439 | 6233 | 6527 | 6962 | 7256 |
| | IWU122D | 5527 | 5821 | 6615 | 6909 | 7344 | 7638 |

* ohne Hahnloch (preisgleich)/without tap hole (same price)

** zusätzliches Hahnloch (alle preisgleich/additional tap hole (same price))

Smart Maße

Bohrlochhöhen für Schraubhaken, Anschlussmaße und Abflusshöhen

Smart dimensions

Drilling point for screw hooks, dimensions for mounting and drain

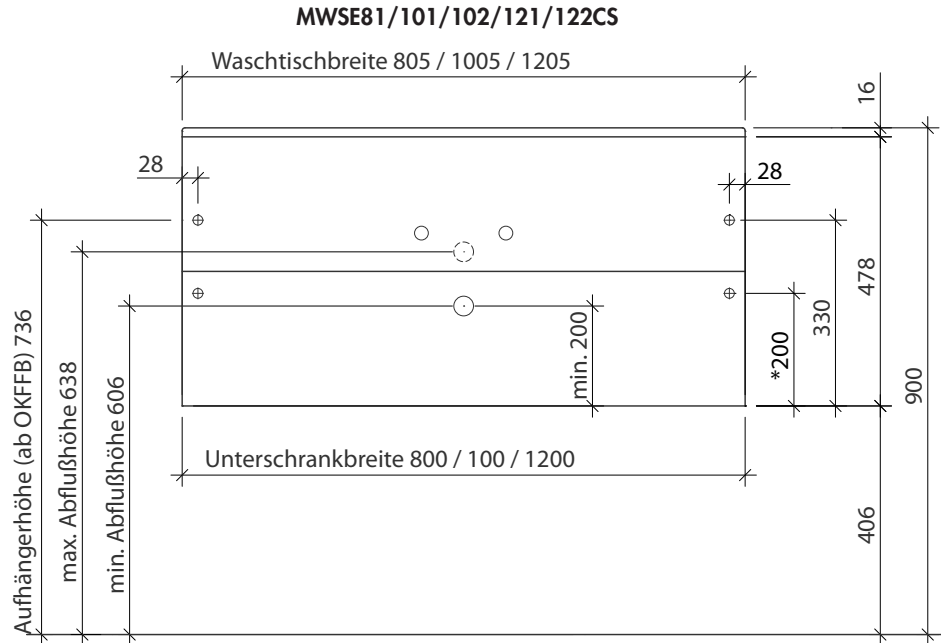

*MWU122D und IWU122D mit 4 Aufhängern
 Waschtisch mit 2 Hahnlöchern (MWSE102/MWSE122) = 1 Abfluß
 *MWU122D and IWU122D with 4 put in hangers
 Washbasin with 2 tap holes (MWSE102/MWSE122) = 1 drain

SPGL80/100/120

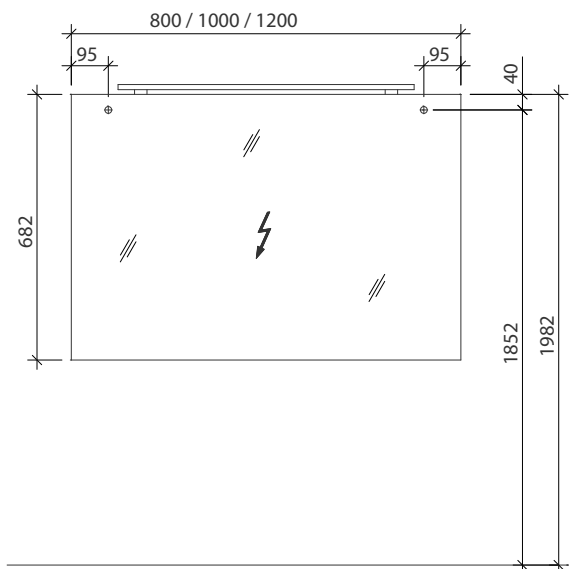

SPSGL80/100/120D

